

LAPAROSCOPY

We Support



DIVINE MEDITECH PVT. LTD.



Manufacturer:

Plot No.: 18, Phase III, Industrial Area, Tahliwal
District Una, Himachal Pradesh – 174301
India

www.divinemeditech.com

info@divinemeditech.com

Delhi Office:

F-3, Building No. 9, A-Block Market,
Surajmal Vihar, Delhi – 110092
India

+91-11-32902571

ABOUT US:

DMPL is an authentic Indian manufacturer specialized in the manufacturing of high end medical devices for various endoscopy applications. We support *"Make in India"* campaign initiated by Govt. of India & aim to be a leading Indian manufacturer in our field.

We are strongly supported by our R & D Teams in India and abroad. Quality is kept intact by adhering to International quality management systems and good manufacturing practices.

DMPL has been fairly successful in satisfying the customer needs by innovations and providing them the products they actually need to excel in their clinical applications.

For the distributors, **DMPL** has succeeded in providing marketable, high quality, cost competitive, reliable and unique specification products which are difficult to be compared by competition. Therefore the channel partners and distributors can provide excellent products to their markets at fair margins.

DMPL products are being used by leading medical colleges, universities, corporate hospitals, research institutes and medical professionals in India and abroad. Delighted customers in hospitals as well as happy distributors are a testimony to our success.

DMPL has the capacity to produce the medical devices according to the requirements of the customers and plans to concentrate on major distributors and OEM partners for further business expansion.



OEM:

"Where Outsourcing comes full circle"

As an original medical device manufacturer **DMPL** provides traditional high quality contract manufacturing services whereupon our skilled engineers can develop and design our products according to your specifications, name, logo and design from start to finish.

This facility of OEM manufacturing is especially useful to those companies who do not wish to build their own manufacturing capability or wish to outsource the manufacture of their products.

Some reputed Companies / brands are already availing the OEM capability offered by **DMPL** under OEM contract.

For OEM / ODM queries,
please contact us at:
info@divinemeditech.com

INDEX

S.NO.	DESCRIPTION	PAGE NO.
1	Trocars-Cannula	3
2	Standard Trocars & Sleeves	4
3	Lower Tubes for Trocars	5
4	Trocars	6
5	Hasson Cone & Reducers	7
6	Palpation Probes / Dilation Sets & Aspiration & Puncture Needles	8
7	Knot Pushers & Retractors	9
8	Suction Irrigation Cannula & Clip Applicators	10
9	Monopolar Electrodes	11
10	Veress Needle & Bipolar Coagulation Forceps	12
11	Grasping & Dissecting Forceps – 5mm / Handles	13-15
12	10 mm Grasping & Dissecting Forceps / HF Cord	16-17
13	Needle Holders & Ring Applicators	18
14	Manipulators	19
15	Myoma Screw & Cuscus Speculum	20
16	Colposcopy Ball / Loops	21
17	Accessories	22

*Color, specification, shape may vary due to ongoing product development

*Due to space constraints, pictures of some products are not included.

TROCARS – CANNULA

Magnetic Trocars & Cannulas

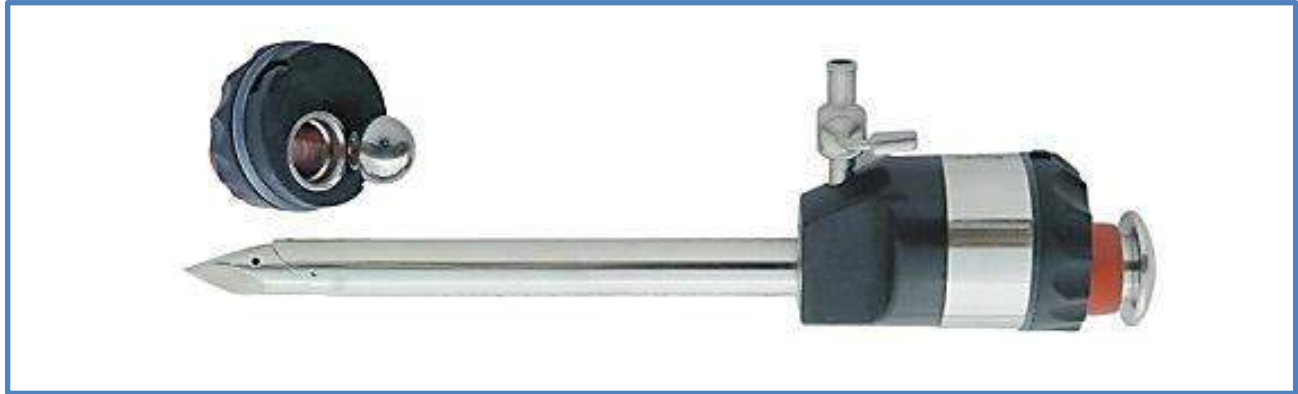

S.NO.	DESCRIPTION	ART NO.	DIAMETER	WORKING LENGTH
01	Magnetic Cannula with Std. Trocar	DM-102-008	Ø 10.5 mm	95 mm
02	Std. Trocar only for Magnetic Cannula	DM-TR-10-95	Ø 10.5 mm	95 mm
03	Magnetic Cannula with protective Trocar	DM-102-010	Ø 10.5 mm	95 mm
04	Protective Trocar only for Magnetic Cannula	DM-STR-10-95	Ø 10.5 mm	95 mm
05	Magnetic Cannula with Std. Trocar	DM-102-009	Ø 5.5 mm	95 mm
06	Std. Trocar only for Magnetic Cannula	DM-TR-55-95	Ø 5.5 mm	95 mm
07	Magnetic Cannula with protective Trocar	DM-102-011	Ø 5.5 mm	95 mm
08	Protective Trocar only for Magnetic Cannula	DM-STR-55-95	Ø 5.5 mm	95 mm

Standard Trocars & Sleeves

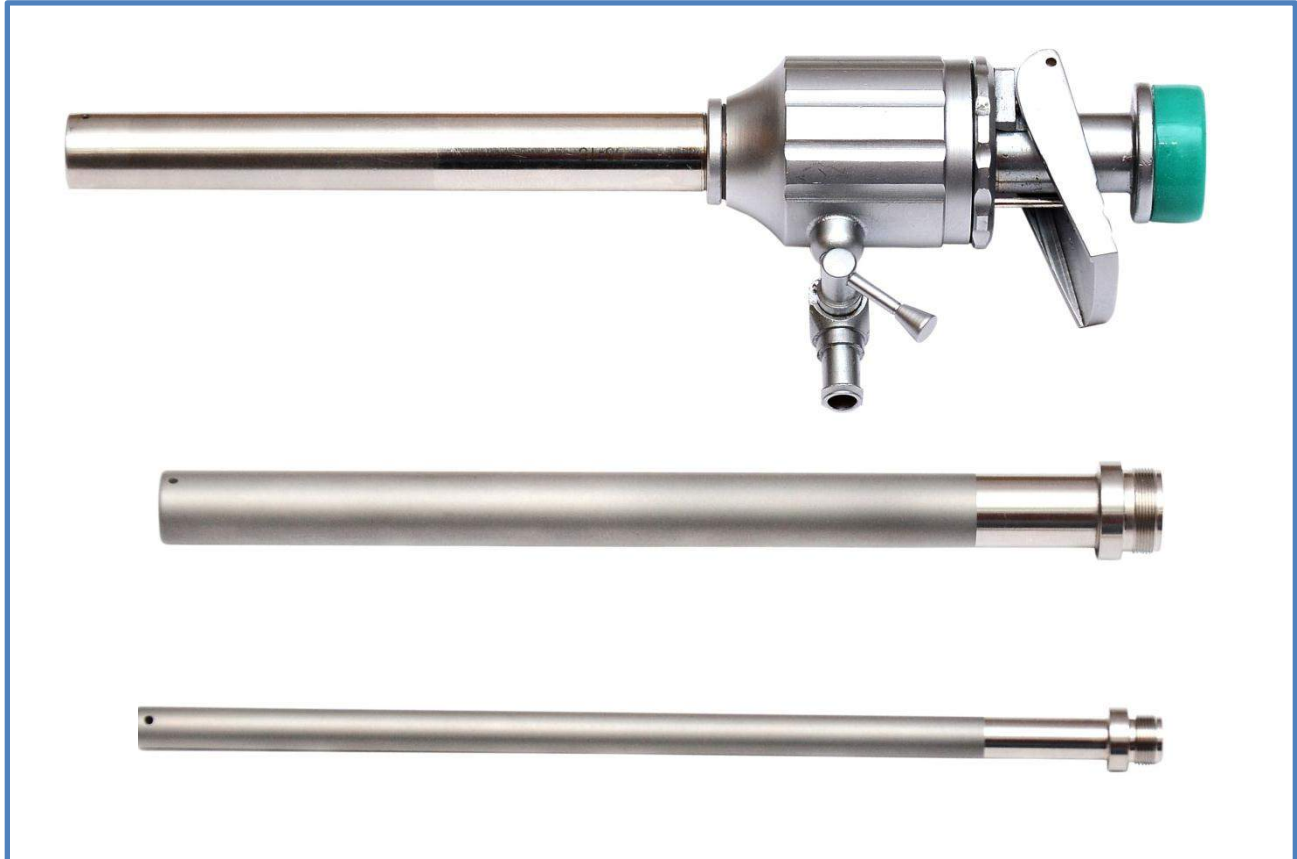

S.NO.	DESCRIPTION	ART NO.	DIAMETER	WORKING LENGTH
01	Automatic (Flap valve) Cannula, Modular 3 parts, External activation	DM-100-1000	Ø 10.5 mm	100 mm
02	Automatic (Flap valve) Cannula, Modular 3 parts, External activation	DM-100-070	Ø 7 mm	100 mm
03	Automatic (Flap valve) Cannula, Modular 3 parts, External activation	DM-100-055	Ø 5.5 mm	100 mm

Lower Tubes for Trocars

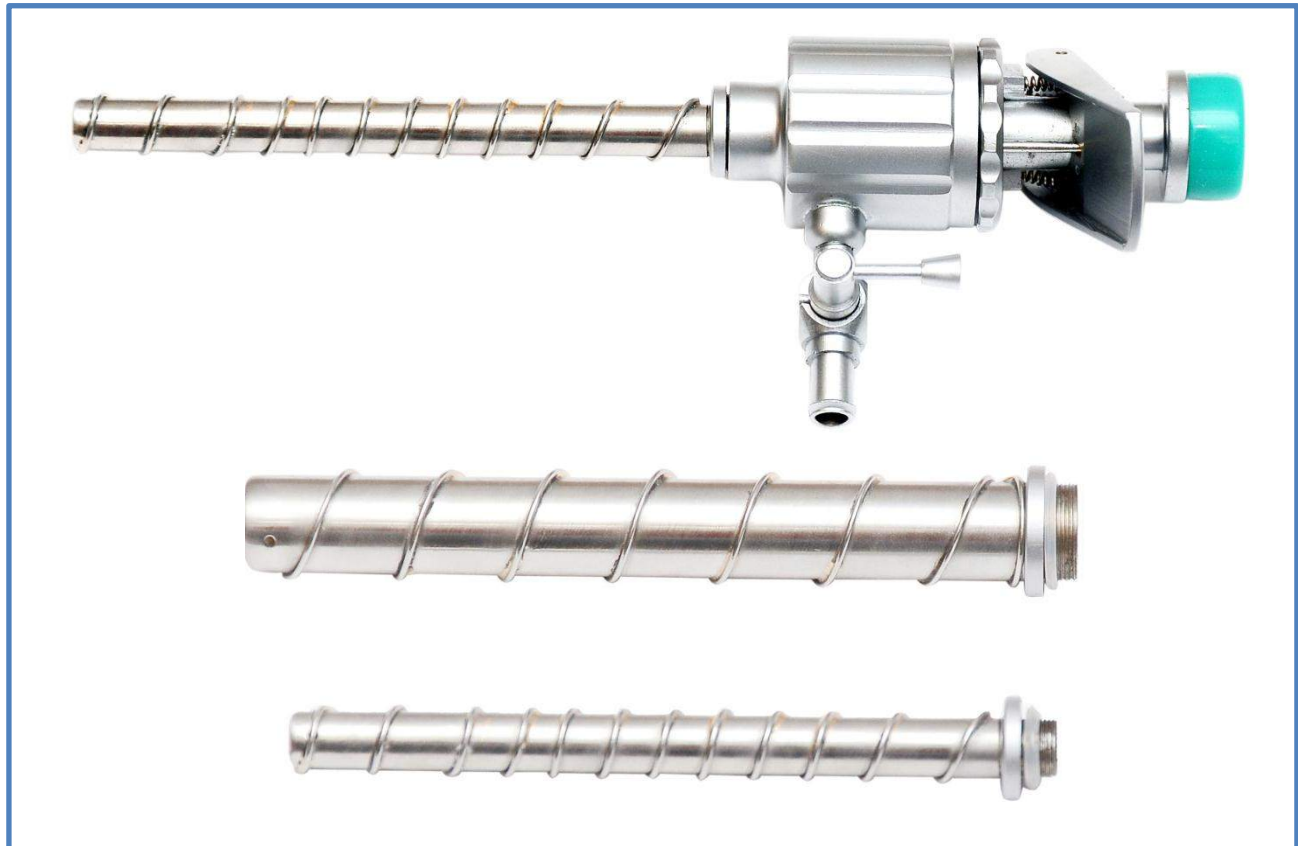

S.NO.	DESCRIPTION	ART NO.	DIAMETER	WORKING LENGTH
01	Extra Length Lower Tube for bariatric applications	DM-TB-55-150	Ø 5.5	150 mm
02	Extra Length Lower Tube for bariatric applications	DM-TB-10-150	Ø 10.5	150 mm
03	Extra Length lower tube spiral for bariatric application	DM-STB-55-150	Ø 5.5	150 mm
04	Extra Length lower tube spiral for bariatric application	DM-STB-10-150	Ø 10.5	150 mm
05	Std. Lower Tube of 5.5 mm Cannula	DM-TB-55-100	Ø 5.5	100 mm
06	Std. Lower Tube of 10.5 mm Cannula	DM-TB-10-100	Ø 10.5	100 mm
07	Std. Lower tube spiral for 5.5 mm Cannula	DM-STB-55-100	Ø 5.5	100 mm
08	Std. Lower tube spiral for 10.5 mm Cannula	DM-STB-10-100	Ø 10.5	100 mm

TROCARS



S.NO.	DESCRIPTION	ART NO.	DIAMETER	WORKING LENGTH
01	Standard trocar Conical	DM-TC-55-100	Ø 5.5 mm	100 mm
02	Standard trocar Conical	DM-TC-70-100	Ø 7 mm	100 mm
03	Standard trocar Conical	DM-TC-10-100	Ø 10.5 mm	100 mm
04	Standard trocar Blunt	DM-BL-55-100	Ø 5.5 mm	100 mm
05	Standard trocar Blunt	DM-BL-10-100	Ø 10.5 mm	100 mm
06	Standard trocar Pyramidal	DM-TP-55-100	Ø 5.5 mm	100 mm
07	Standard trocar Pyramidal	DM-TP-70-100	Ø 7 mm	100 mm
08	Standard trocar Pyramidal	DM-TP-10-100	Ø 10.5 mm	100 mm
09	Extra Length Standard Trocar for Bariatric Application	DM-TP-55-150	Ø 5.5 mm	150 mm
10	Extra Length Standard Trocar for Bariatric Application	DM-TP-10-150	Ø 10.5 mm	150 mm

HASSON CONE

S.NO.	DESCRIPTION	ART NO.	DIAMETER
01	Hasson cone without suture holder	DM-HAS-10-11	10-11 mm
02	Standard trocar Blunt	DM-BL-10-100	10-11 mm



REDUCERS



S.NO.	DESCRIPTION	ART NO.	DIAMETER	WORKING LENGTH
01	Reducer with Silicon latch for automatic Cannula	DM-RE-105	10-5mm	Short
02	Reducer with Silicon latch for automatic Cannula	DM-RE-109	5-3 mm	Short

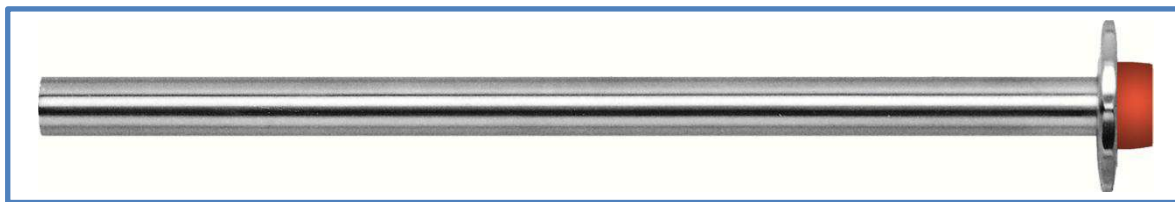

S.NO.	DESCRIPTION	ART NO.	DIAMETER	WORKING LENGTH
01	Metallic Reducer	DM-RE-106	10-11/5.5 mm	Standard
02	Metallic Reducer	DM-RE-107	12.5/10 mm	Standard
03	Metallic Reducer	DM-RE-108	12.5/5.5 mm	Standard

PALPATION PROBES

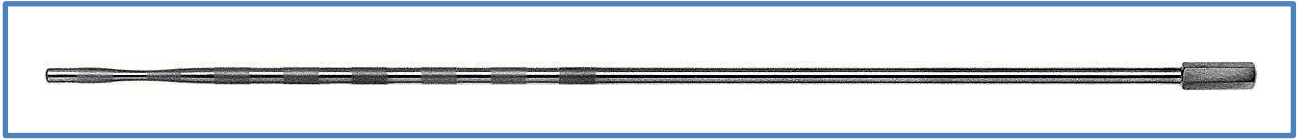

S.NO.	DESCRIPTION	ART NO.	DIAMETER	WORKING LENGTH
01	Palpation Probes	DM-PP-100	5 mm	330 mm
02	Palpation Probes	DM-PP-101	5 mm	450 mm

DILATION SETS



S.NO.	DESCRIPTION	ART NO.	DIAMETER	WORKING LENGTH
01	Dilation Sets	DM-DS-100	5-10 mm	Standard
02	Dilation Sets	DM-DS-101	5-11 mm	Extra Length

ASPIRATION & PUNCTURE NEEDLES



S.NO.	DESCRIPTION	ART NO.	DIAMETER	WORKING LENGTH
01	Aspiration Needle	DM-AN-100	5 mm	300 mm
02	Aspiration Needle	DM-AN-101	5 mm	350 mm

KNOT PUSHERS

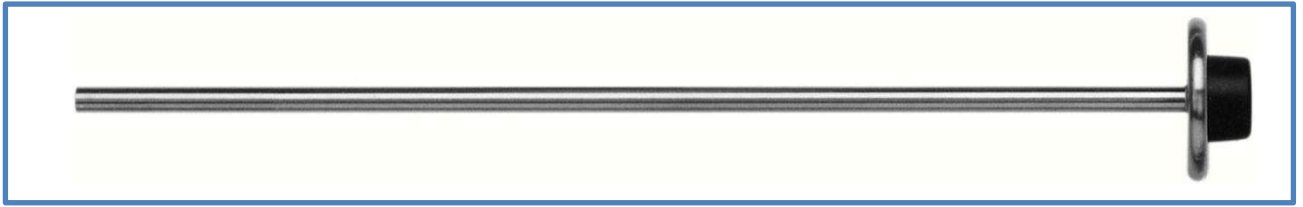

S.NO.	DESCRIPTION	ART NO.	DIAMETER	WORKING LENGTH
01	Knot Applicator	DM-KA-100	5-4 mm	175 mm
02	Knot Pusher	DM-KP-100	4 mm	330 mm

RETRACTORS

Liver / Fan Retractor



S.NO.	DESCRIPTION	ART NO.	DIAMETER	WORKING LENGTH
01	Fan Retractor (Three Leaves)	DM-102-077A	5 mm	330 mm
02	Fan / Liver Retractor (Five Leaves)	DM-102-078	10 mm	330 mm

SUCTION IRRIGATION CANNULA

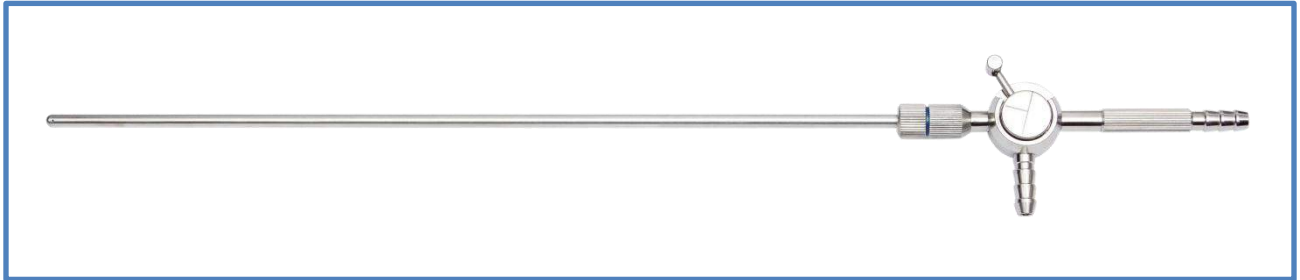

S.NO.	DESCRIPTION	ART NO.	DIAMETER	WORKING LENGTH
01	Suction Irrigation Thumb Control	DM-102-080-A	5 mm	330 mm
02	Suction Irrigation Trumpet	DM-102-081-A	5 mm	330 mm
03	Suction Irrigation Thumb Control	DM-102-080-B	10 mm	330 mm
04	Suction Irrigation Trumpet	DM-102-081-B	10 mm	330 mm

CLIP APPLICATORS

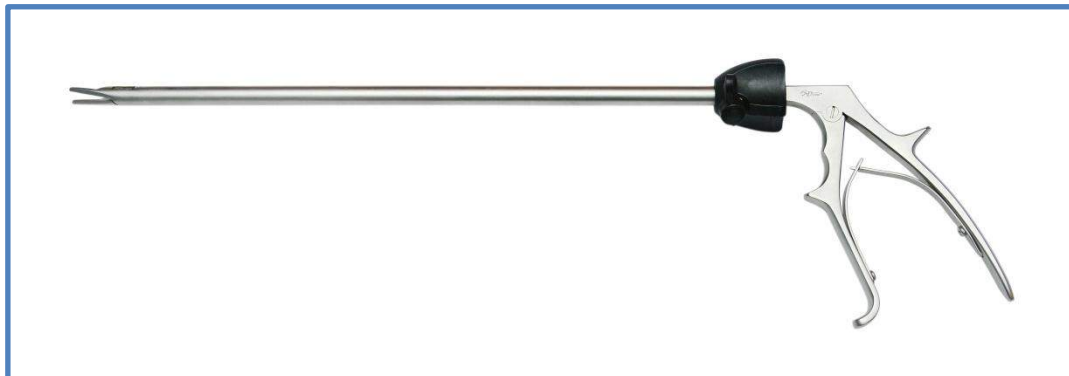

S.NO.	DESCRIPTION	ART NO.	DIAMETER	WORKING LENGTH
01	Clip Applicators Rotatable LT 300 Medium Large	DM-102-098	10 mm	330 mm
02	Clip Applicators Rotatable LT 400 Large	DM-102-099	10 mm	330 mm
03	Clip Applicators Rotatable with three attachment (200,300,400)	DM-200-400	10 mm	330 mm
04	Clip Applicators Rotatable LT 200	DM-103-026	5 mm	330 mm
05	Hemo Lock Clip Applicator	DM-102-101	10 mm	330 mm

MONOPOLAR ELECTRODES



S.NO.	DESCRIPTION	ART NO.	DIAMETER	WORKING LENGTH
01	L-Hook with ceramic beak	DM-101-001	5 mm	330 mm
02	Hook cannula with suction	DM-HC-002	5 mm	330 mm
03	Monopolar Electrodes J-Hook	DM-MJ-003	5 mm	330 mm
04	Spatula Electrode	DM-101-004	5 mm	330 mm
05	Spatula Electrode with Suction	DM-SS-005	5 mm	330 mm
06	Needle Electrode	DM-NE-006	5 mm	330 mm
07	Ball Electrode	DM-BE-007	5 mm	330 mm
08	Knife Electrode	DM-KE-008	5 mm	330 mm

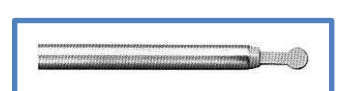
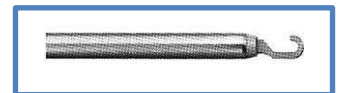
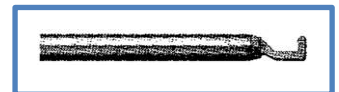

VERESS NEEDLE



S.NO.	DESCRIPTION	ART NO.	WORKING LENGTH
01	Veress Needle	DM-VN-100	100 mm
02	Veress Needle	DM-VN-120	120 mm
03	Veress Needle	DM-VN-130	130 mm
04	Veress Needle	DM-VN-150	150 mm
05	Veress Needle	DM-VN-170	170 mm
06	Veress Needle	DM-VN-200	200 mm

BIPOLAR COAGULATION FORCEPS

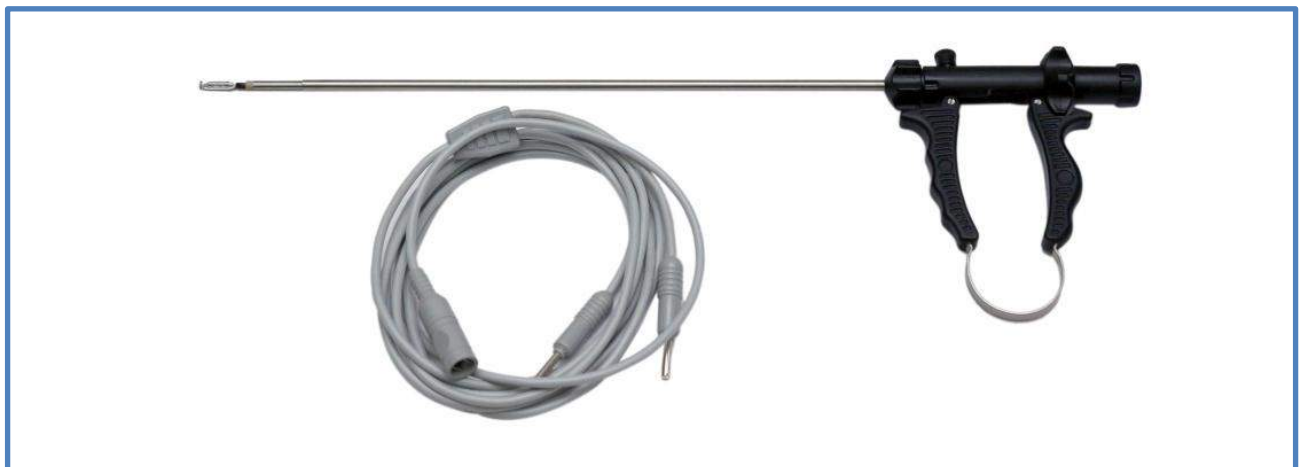

S.NO.	DESCRIPTION	ART NO.	DIAMETER	WORKING LENGTH
01	Bipolar Coagulation Forceps (Rippled Bar)- Waved	DM-101-011	5 mm	300 mm
02	Bipolar Coagulation Forceps (Maryland) - Curved	DM-101-010	5 mm	300 mm
03	Bipolar Cables 2 Banana Plug	DM-101-014	5 mm	Standard
04	Bipolar Forcep Maryland (Power Grip)	DM-101-013	5 mm	300 mm
05	Bipolar Forcep Grasper (Power Grip)	DM-101-013-A	5 mm	300 mm

GRASPING & DISSECTING FORCEPS – 5 MM

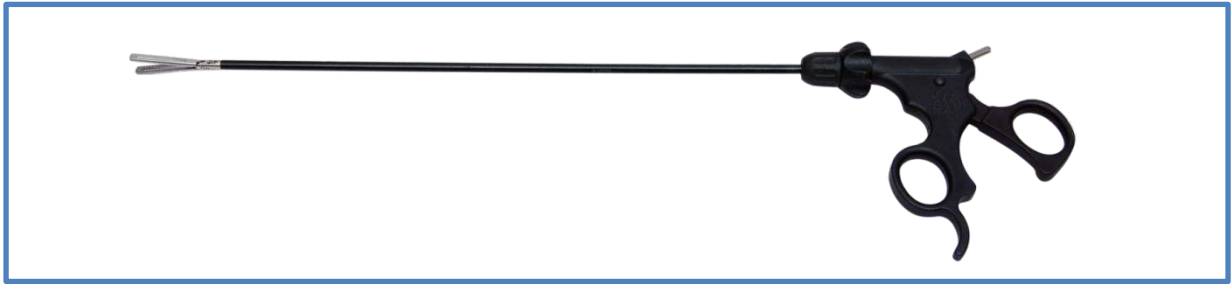

S.NO.	DESCRIPTION	ART NO.	DIAMETER	WORKING LENGTH
01	Fenestrated grasper double action	DM-102-047	5 mm	330 mm
02	Bowel/Dorsey grasper double action	DM-102-052	5 mm	330 mm
03	Babcock double action jaw	DM-102-044	5 mm	330 mm
04	Oviduct grasper	DM-102-058	5 mm	330 mm
05	Allis grasper	DM-102-090	5 mm	330 mm
06	Curved Scissor double action	DM-102-030	5 mm	330 mm
07	Maryland Dissector double action	DM-102-020	5 mm	330 mm



08	Dolphin grasper	DM-102-123	5 mm	330 mm	
09	Biopsy Punch Forcep	DM-102-075	5 mm	330 mm	
10	Alligator Forcep	DM-102-066	5 mm	330 mm	
11	Right angle dissector	DM-102-022	5 mm	330 mm	
12	Stomach Grasping Forcep	DM-102-088-A	5 mm	330 mm	
13	Maxigrip/Universal Grasper	DM-102-065	5 mm	330 mm	
14	Curved scissor	DM-102-029	5 mm	330 mm	
15	Rat Tooth Grasper forcep (2x4)	DM-102-121-A	5 mm	330 mm	
16	Alligator claw grasper	DM-102-061	5 mm	330 mm	

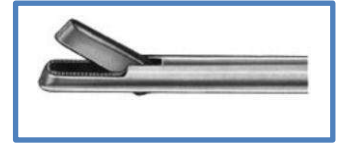

17	Hook scissor	DM-102-031	5 mm	330 mm
18	Straight scissor	DM-102-027	5 mm	330 mm



HANDLES









S.NO.	DESCRIPTION	ART NO.
01	Plastic Free moving Handle (Type B)	DM-B-0020-B

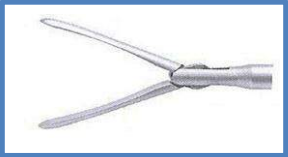
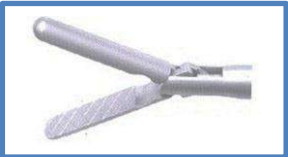

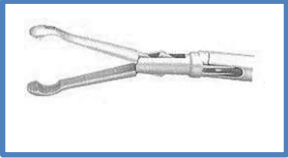
S.NO.	DESCRIPTION	ART NO.
01	Plastic Handle With Ratchet (Type B)	DM-B-0021-B

10 MM GRASPING & DISSECTING FORCEPS

S.NO.	DESCRIPTION	ART NO.	DIAMETER	WORKING LENGTH	
01	Broadness Mouth Forceps	DM-105-003	10 mm	330 mm	
02	Atraumatic Forceps	DM-105-004	10 mm	330 mm	
03	Grasping Forceps (Long-Jaw)	DM-105-005	10 mm	330 mm	
04	Duck-Jaw Forceps	DM-105-006	10 mm	330 mm	
05	Gallbladder Grasping Forceps	DM-102-110	10 mm	330 mm	
06	Biopsy Forceps	DM-102-107	10 mm	330 mm	
07	Grasping forceps	DM-102-110-A	10 mm	330 mm	
08	Single Tooth Grasper	DM-102-129	10 mm	330 mm	

09	Dissecting Forceps (Curved)	DM-102-024	10 mm	330 mm
10	Scissors (Double – Action Straight)	DM-102-025	10 mm	330 mm
11	Right angle dissector	DM-102-023	10 mm	330 mm
12	Single tooth Grasping / Tenaculam	DM-102-129	10 mm	330 mm

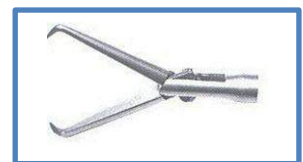
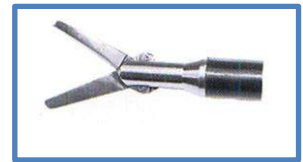

HF CORD



S.NO.	DESCRIPTION	ART NO.	WORKING LENGTH
01	Monopolar Cable	DM-101-015	Standard

NEEDLE HOLDERS



S.NO.	DESCRIPTION	ART NO.	DIAMETER	WORKING LENGTH
01	Needle holder straight	DM-102-036-A	5 mm	330 mm
02	Needle holder right curved	DM-102-036-B	5 mm	330 mm
03	Needle holder pistol type	DM-102-040-A	5 mm	330 mm
04	Needle holder (V) Axial	DM-102-033-A	5 mm	330 mm

RING APPLICATORS



S.NO.	DESCRIPTION	ART NO.	DIAMETER	WORKING LENGTH
01	Ring Applicator for Single Puncture	DM-RP-001	6 mm	327 mm
02	Ring Applicator for Double Puncture	DM-DP-002	6.5 mm	330 mm
03	Loader	DM-LO-003	-	-
04	Pusher	DM-PS-004	-	-

MANIPULATORS

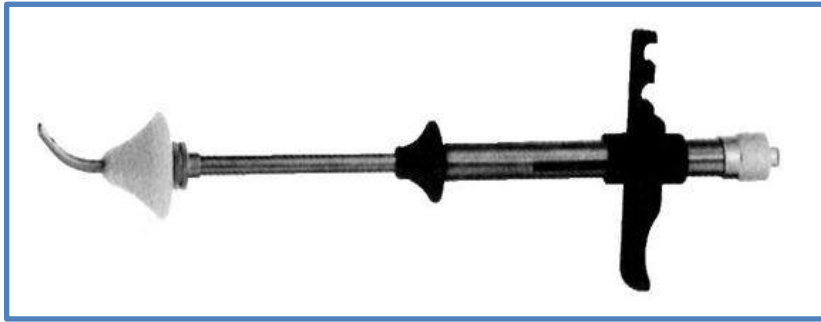

S.NO.	DESCRIPTION	ART NO.
01	Vaginal Manipulator / Cohen's Cannula	DM-203-001

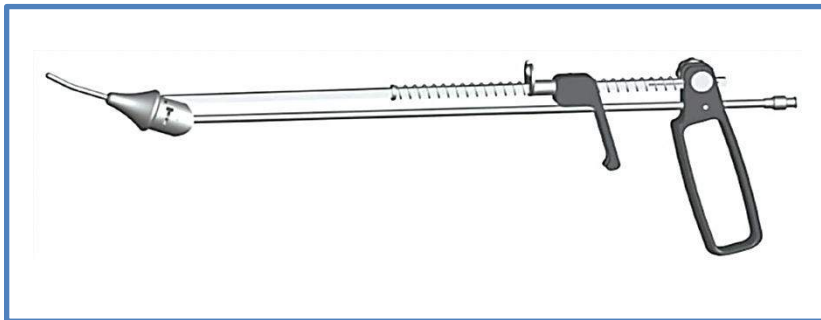

S.NO.	DESCRIPTION	ART NO.
01	Uterine Manipulator Cannula Intensive type (Complete with Acorns)	DM-203-003



S.NO.	DESCRIPTION	ART NO.
01	CLL Vaginal Extractor	DM-203-002

MYOMA SCREW

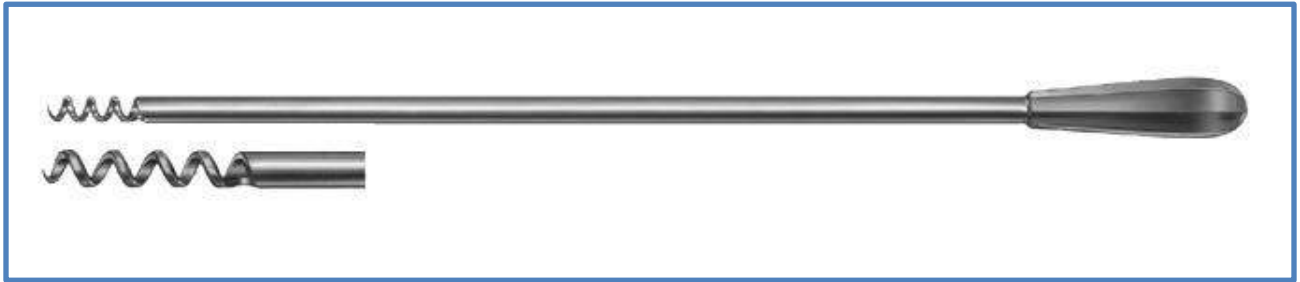

S.NO.	DESCRIPTION	ART NO.	DIAMETER	WORKING LENGTH
01	Myoma Drill	DM-201-021	5 mm	330 mm
02	Myoma Drill	DM-201-020	10 mm	330 mm

CUSCUS SPECULUM



S.NO.	DESCRIPTION	ART NO.	WORKING LENGTH
01	Speculum	DM-SS-001	Small
02	Speculum	DM-SS-002	Medium
03	Speculum	DM-SS-003	Large
04	Speculum Insulated	DM-SS-004	Small
05	Speculum Insulated	DM-SS-005	Medium
06	Speculum Insulated	DM-SS-006	Large

COLPOSCOPY BALL / LOOPS



S.NO.	DESCRIPTION	ART NO.	WORKING LENGTH
01	Ball Electrode	DM-COL-001	Small
02	Ball Electrode	DM-COL-002	Large



S.NO.	DESCRIPTION	ART NO.	WORKING LENGTH
01	Loop Electrode	DM-COL-003	Small
02	Loop Electrode	DM-COL-004	Medium
03	Loop Electrode	DM-COL-005	Large
04	Square Electrode	DM-COL-006	Small
05	Square Electrode	DM-COL-007	Large

ACCESSORIES

S.NO.	DESCRIPTION	ART NO.
01	FOC Connector Light Source	DM-FOC-003
02	FOC Connector Telescope side	DM-FOC-004
03	High Pressure tubing Pin Index	DM-HPT-001
04	High Pressure tubing (B & B)	DM-HPT-002
04	Light Source Bulb Halogen 24v/250W	DM-HL-250-24
05	Light Source Bulb Halogen 15V/150W	DM-HL-150-15
06	Xenon Lamp for 180 W Light Source	DM-180-W
07	Xenon Lamp for 300 Watt Xenon	DM-300-W

